

Article number: 2310307525ESD

Description: E+G Antistatic base for levelling elements
LV.A-60-14-AS-M16x108-ESD-C

Measures

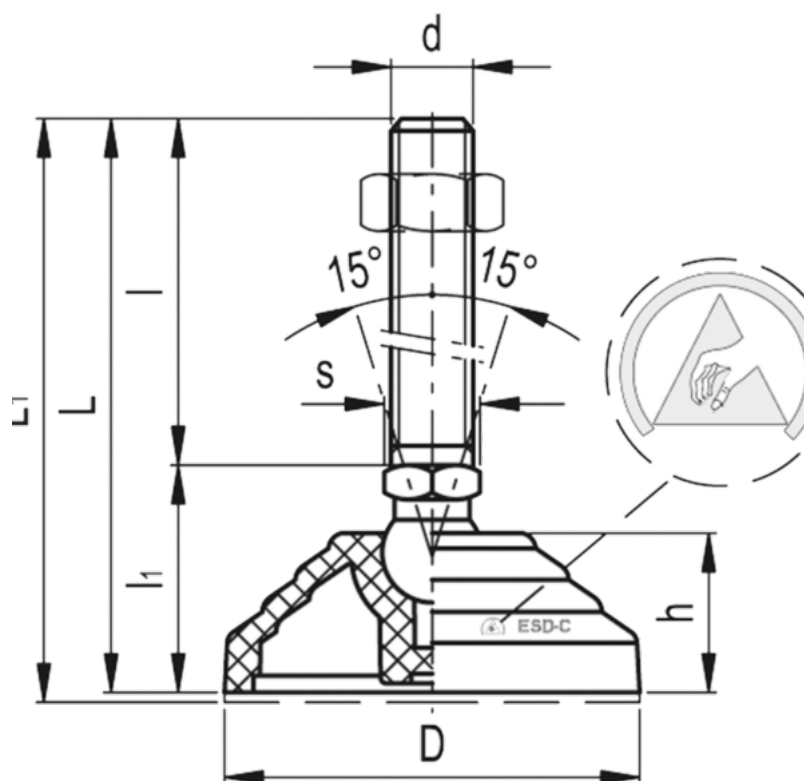

Articulation	= 14	Max load	= 14000
D	= 60	s	= 16
d	= M16	Weight in (g)	= 213
h	= 24		
l	= 108		
l1	= 33		
L	= 141		
L1	= 144		